

NDL
FITTING YOUR NEEDS
Transformer



NDL INDUSTRIES INC.

The high quality that you require at competitive prices.

24001MWL

With Circuit Breaker

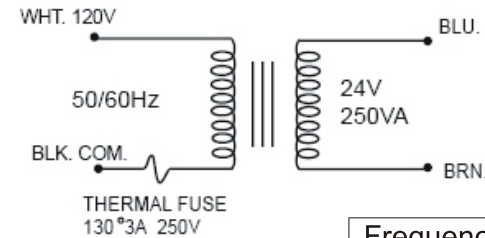
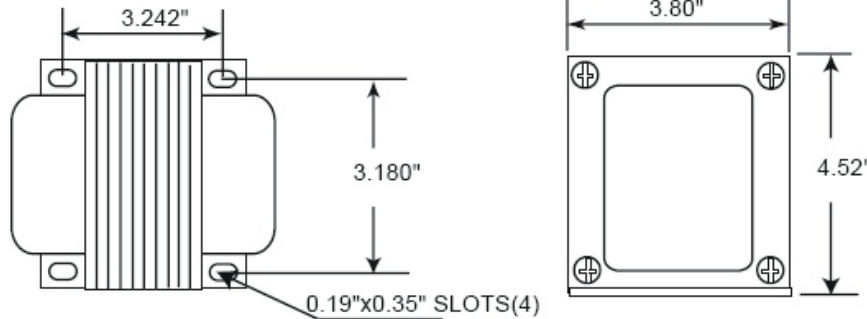

Frequency	50/60HZ
Power Rating	250VA
Primary Voltage	120
Secondary Voltage	24
Insulation System	Class B

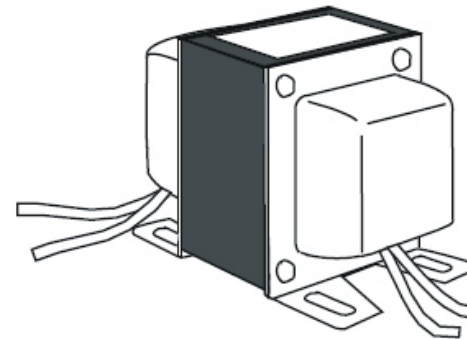
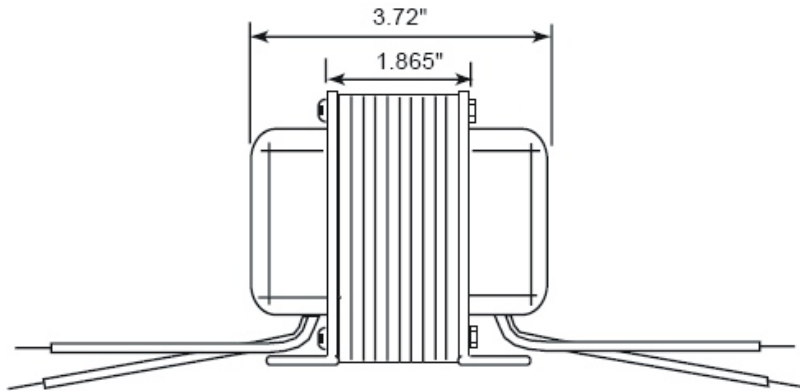

UL1015#18 LENGTH 8" IN COLOR
"BLACK" & "WHITE"

UL1015#18 LENGTH 8" IN COLOR
"BLUE" & "BROWN"

UNIT: inch ± 0.04

NDL INDUSTRIES INC.

266 S.W. Marine Drive, Vancouver, BC Canada V5X 2R5
Toll Free 1 866 635 6888 Tel. (604) 736 7470 Fax (604) 736 0164

www.ndlinc.com